

5 40 354 121 00







**Basis Steile
aanbouwlijbaan PH
195 cm, roestvrij staal**
made in germany

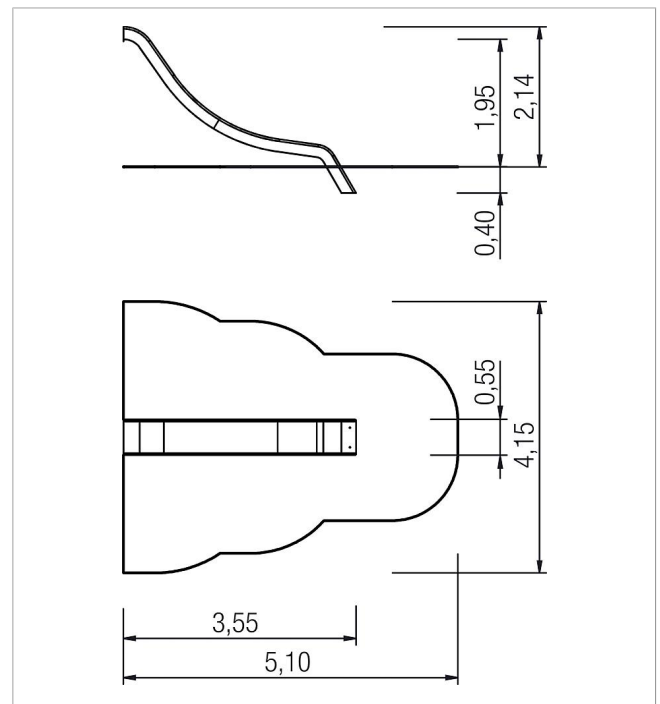

Leveringsomvang

1x glijbaan: roestvrij staal
bevestigingsmateriaal: roestvrij staal



	Materiaal	roestvrij staal
	fundering	ET 400
	vrije ruimte	5,10x4,15x3,75 m
	vrije valhoogte	195 cm
	valdemping netto	16,0 m ²
	fundamenten	1x SF of 1x PFK